

AA2300

Cylindrical Ni-MH Battery

@ Specification

Cross Reference: IEC-HR15/51

Nominal Voltage (V)		1.2
Dimensions	Diameter (mm)	14.5 ⁺⁰ / _{-0.7}
	Height (mm)	50.5 ⁺⁰ / _{-2.0}
Nominal Capacity		2300mAh
Apx. Weight (g)		30.0
Internal Impedance		Less than 30mO
Cycle Life		500 cycles
Condition		Ambient Temp.
Charge	Standard (230mA)	0°C-40°C
	Fast (2300mA)	10°C-40°C
Discharge		-10°C-50°C
Storage	Less than 90days	-10°C-40°C
	Less than 1 year	-10°C-30°C

@ Dimensions

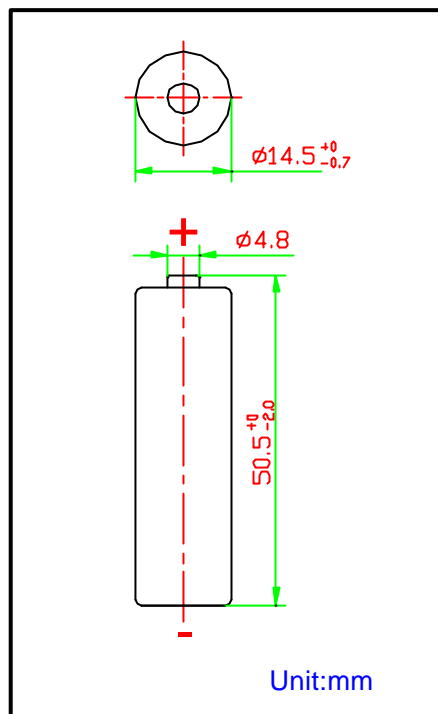

@ Typical Charge Characteristics

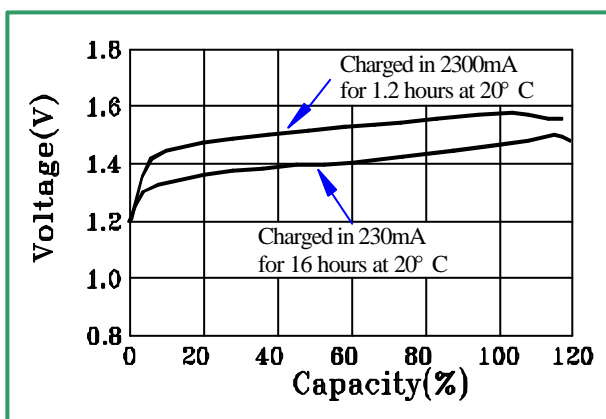

@ Typical Discharge Characteristics

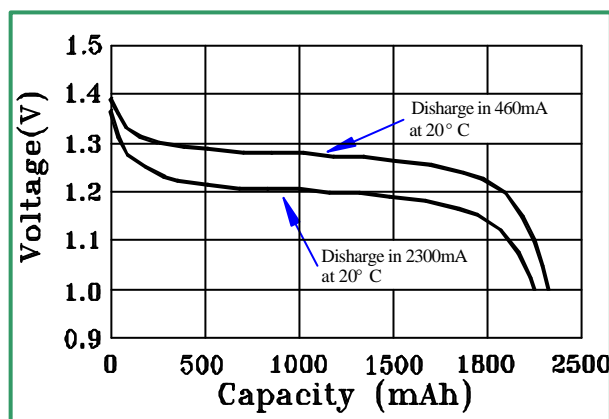

Add: No.2, Gutang'ao Industrial Area, Huizhou, Guangdong, China

P.C.: 516008

Tel: +86-752-2382997, +86-13502288850

Fax: +86-752-2382786

Website: www.cn-battery.net

E-mail: zhou01@yeah.net

