

# CR1620

## Coin Lithium Battery

### @ Specifications

<b>Nominal Voltage</b>		<b>3.0 V</b>
<b>Dimensions</b>	<b>Diameter</b>	$16.0^{+0}/_{-0.3}$ mm
	<b>Height</b>	$2.0^{+0}/_{-0.2}$ mm
	<b>Apx. Weight</b>	<b>1.4 g</b>
<b>Standard Discharge Condition</b>	<b>Load</b>	<b>30 k ohms</b>
	<b>Temperature</b>	<b>20 °C</b>
	<b>Cut off volt.</b>	<b>2.0 V</b>
<b>Nominal Capacity</b>		<b>70 mAh</b>
<b>Operating Temp.</b>		<b>-20 – 60 °C</b>
<b>Storage</b>	<b>Temperature</b>	<b>20 – 25 °C</b>
	<b>Relative Humidity</b>	<b>&lt; 75%</b>

### @ Dimensions

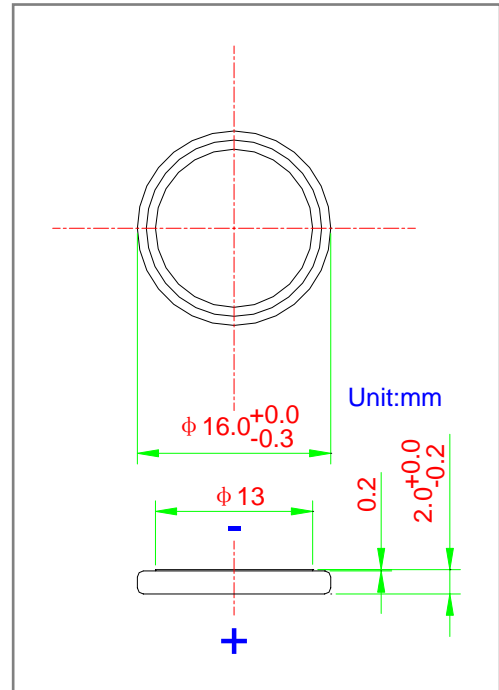

### @ Discharge Characteristics vs. Load

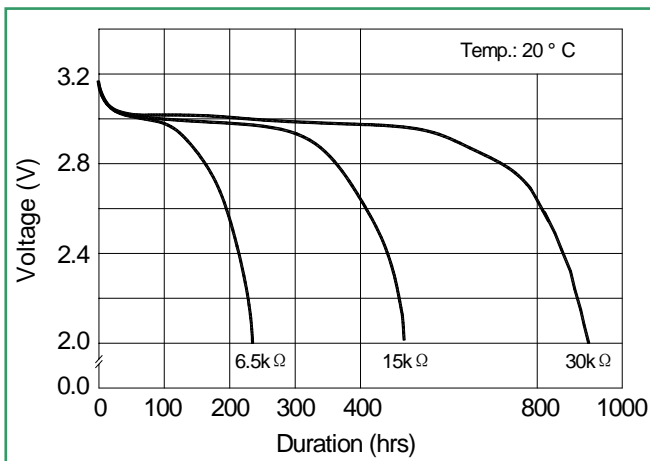

### @ Capacity vs. Load and Temp.

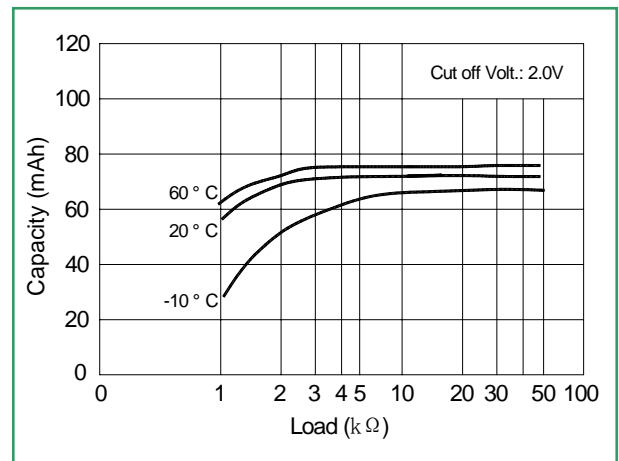

**Add:** No.2, Gutang'ao Industrial Area, Huizhou, Guangdong, China  
**P.C.:** 516008  
**Tel:** +86-752-2382997, +86-13502288850  
**Fax:** +86-752-2382786  
**Website:** [www.cn-battery.net](http://www.cn-battery.net)  
**E-mail:** [zhou01@yeah.net](mailto:zhou01@yeah.net)

