

CR1025

Coin Lithium Battery

@ Specifications

Nominal Voltage		3.0 V
Dimensions	Diameter	10.0^{+0/-0.3} mm
	Height	2.5^{+0/-0.3} mm
	Apx. Weight	0.9 g
Standard Discharge Condition	Load	62 k ohms
	Temperature	20 °C
	Cut off volt.	2.0 V
Nominal Capacity		30 mAh
Operating Temp.		-20 – 60 °C
Storage	Temperature	20 – 25 °C
	Relative Humidity	< 75%

@ Dimensions

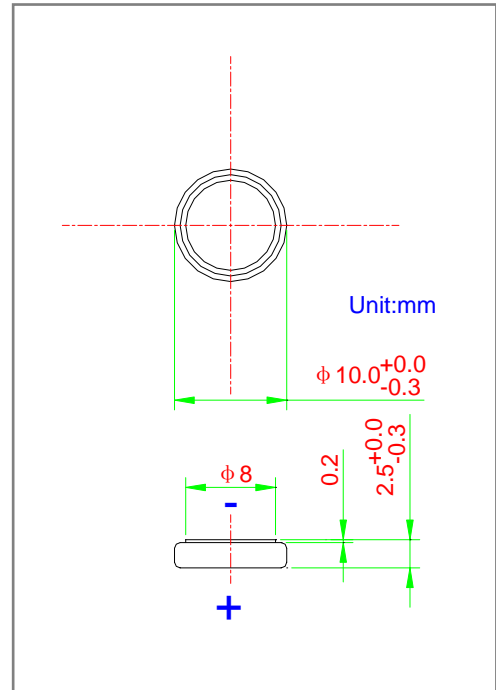

@ Discharge Characteristics vs. Load

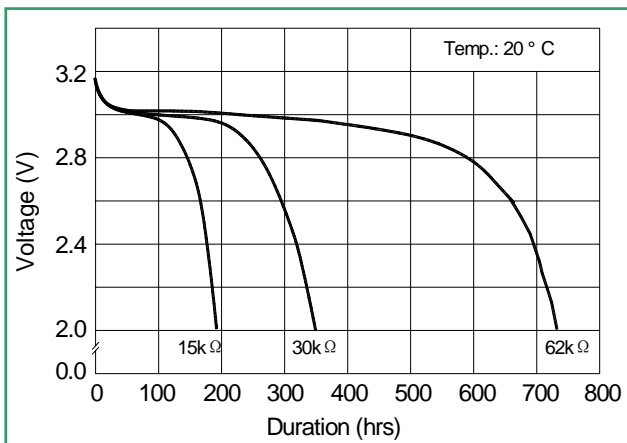

@ Capacity vs. Load and Temp.

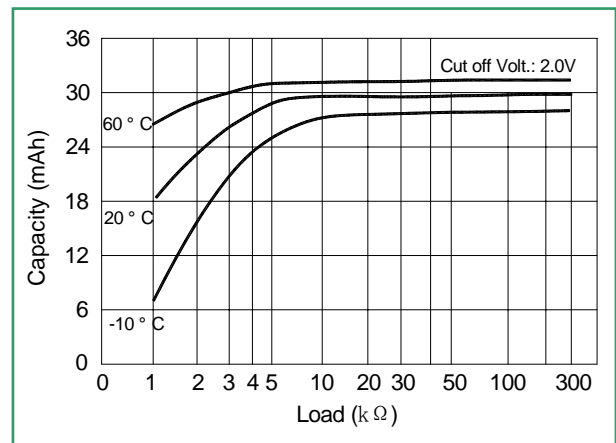

Add: No.2, Gutang'ao Industrial Area, Huizhou, Guangdong, China
P.C.: 516008
Tel: +86-752-2382997, +86-13502288850
Fax: +86-752-2382786
Website: www.cn-battery.net
E-mail: zhou01@yeah.net

